

# BLAZOR

User Manual

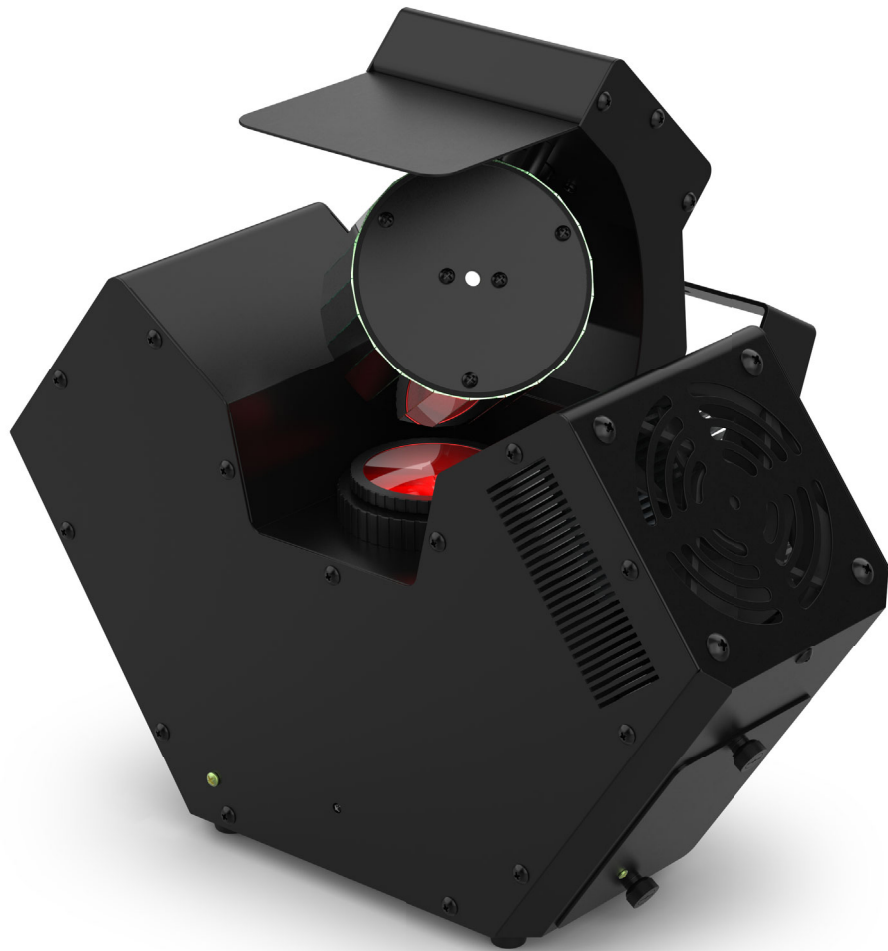



## Edition Notes

The Blazor User Manual includes a description, safety precautions, installation, programming, operation, and maintenance instructions for the Blazor as of the release date of this edition.

### Trademarks

Chauvet, Chauvet DJ, the Chauvet logo, and Blazor are registered trademarks or trademarks of Chauvet & Sons, LLC (d/b/a Chauvet and Chauvet Lighting) in the United States and other countries. Other company and product names and logos referred to herein may be trademarks of their respective companies.

### Copyright Notice

The works of authorship contained in this manual, including, but not limited to, all designs, text, and images are owned by Chauvet.

© Copyright 2025 Chauvet & Sons, LLC. All rights reserved.

Electronically published by Chauvet in the United States of America.

### Manual Use

Chauvet authorizes its customers to download and print this manual for professional information purposes only. Chauvet expressly prohibits the usage, copy, storage, distribution, modification, or printing of this manual or its content for any other purpose without written consent from Chauvet.

### Document Printing

For best results, print this document in color, on letter size paper (8.5 x 11 in), double-sided. If using A4 paper (210 x 297 mm), configure the printer to scale the content accordingly.

### Intended Audience

Any person installing, operating, and/or maintaining this product should completely read through the guide that shipped with the product, as well as this manual, before installing, operating, or maintaining this product.

### Disclaimer

Chauvet believes that the information contained in this manual is accurate in all respects. However, Chauvet assumes no responsibility and specifically disclaims any and all liability to any party for any loss, damage, or disruption caused by any errors or omissions in this document, whether such errors or omissions result from negligence, accident, or any other cause. Chauvet reserves the right to revise the content of this document without any obligation to notify any person or company of such revision; however, Chauvet has no obligation to make, and does not commit to make, any such revisions.

### Document Revision

Go to [www.chauvetdj.com](http://www.chauvetdj.com) for the latest version.

Revision	Date	Description
2	02/2025	DMX chart update

## TABLE OF CONTENTS

<b>1. Before You Begin</b> .....	1
What Is Included .....	1
Unpacking Instructions .....	1
Claims .....	1
Text Conventions .....	1
Symbols .....	1
Safety Notes .....	2
RF Exposure Warning for North America and Australia .....	2
<b>2. Introduction</b> .....	3
Product Overview .....	3
Product Dimensions .....	4
<b>3. Setup</b> .....	5
AC Power .....	5
Fuse Replacement .....	5
Power Linking .....	5
Mounting .....	6
Orientation .....	6
Rigging .....	6
Gobo Wheels .....	7
Replacing Gobos .....	7
Rotating Gobo Dimensions .....	7
<b>4. Operation</b> .....	8
Control Panel Operation .....	8
Menu Map .....	8
DMX Configuration .....	9
Personality and Starting Address .....	9
DMX Channel Assignments and Values .....	10
DMX Charts .....	10
Standalone Configuration .....	12
Auto Programs .....	12
Auto Speed .....	12
Sound-Active Mode .....	12
Sound Sensitivity .....	12
Dimmer .....	12
Manual Mode .....	12
Color .....	12
Gobo .....	12
Gobo Rotation .....	13
Mirror Speed .....	13
Barrel Rotation .....	13
Barrel Pan .....	13
Motor Control Mode .....	13
Mirror rotation: .....	13
Gobo rotation: .....	13
IRC-6 Infrared Remote Control .....	14
Master/Slave Mode .....	15
<b>5. Maintenance</b> .....	16
Product Maintenance .....	16
Gobo Maintenance .....	16
<b>6. Technical Specifications</b> .....	17
<b>Contact Us</b> .....	18
Warranty & Returns .....	18

# 1. Before You Begin

## What Is Included

- Blazor
- Power cable
- Hanging bracket
- Holiday gobo pack
- Quick Reference Guide

## Unpacking Instructions

Carefully unpack the product immediately and check the container to make sure all the parts are in the package and are in good condition.

## Claims





If the box or the contents (the product and included accessories) appear damaged from shipping, or show signs of mishandling, notify the carrier immediately, not Chauvet. Failure to report damage to the carrier immediately may invalidate a claim. In addition, keep the box and contents for inspection.

For other issues, such as missing components or parts, damage not related to shipping, or concealed damage, file a claim with Chauvet within 7 days of delivery.

## Text Conventions

Convention	Meaning
<b>1–512</b>	A range of values
<b>50/60</b>	A set of values of which only one can be chosen
<b>Settings</b>	A menu option not to be modified
<b>&lt;ENTER&gt;</b>	A key to be pressed on the product’s control panel
<b>ON</b>	A value to be entered or selected

## Symbols

Symbol	Meaning
	Electrical warning. Not following these instructions may cause electrical damage to the product, accessories, or the user.
	Critical installation, configuration, or operation information. Not following these instructions may make the product not work, cause damage to the product, or cause harm to the operator.
	Important installation or configuration information. The product may not function correctly if this information is not used.
	Useful information.

### Safety Notes

These Safety Notes include important information about installation, use, and maintenance of the Blazor.



■ **ALWAYS:**

- ◆ Connect to a grounded circuit.
- ◆ Connect to operating voltages as specified on the product's spec sticker.
- ◆ Disconnect from power before replacing the fuse.
- ◆ Disconnect from its power source during periods of inactivity.
- ◆ Use a safety cable when suspending overhead.
- ◆ Heed all restrictions and warnings on the spec sticker.
- ◆ Mount in a location with at least 20 in (50 cm) of ventilation.
- ◆ Replace the fuse with the same type and rating.

- In the event of a serious operating problem, stop using immediately.

■ **DO NOT:**

- ◆ Open this product or attempt any repairs. It contains no user-serviceable parts.
- ◆ Look at the light source when the product is on.
- ◆ Use if the power cable is crimped or damaged.
- ◆ Disconnect by pulling on the power cable.
- ◆ Allow flammable materials close to the product when it is operating.
- ◆ Touch the housing when it is on.
- ◆ Block any ventilation holes/slots in the housing.
- ◆ Connect to a dimmer or rheostat.
- ◆ Carry the product by its power cable.
- ◆ Operate in temperatures higher than 104°F (40°C).
- ◆ Expose to environments that exceed the Ingress Protection (IP) rating.
- ◆ Expose to rain or moisture.
- ◆ Use outdoors.
- ◆ Submerge.
- ◆ Set this product on a flammable surface.



**Keep this User Manual for future use. If the product is sold to someone else, be sure that they also receive this document.**

### RF Exposure Warning for North America and Australia

**Warning!** This equipment complies with FCC radiation exposure limits set forth for an uncontrolled environment. This equipment should be installed and operated with a minimum distance of 20 cm between the radiator and the user. This transmitter must not be co-located or operating in conjunction with any other antenna or transmitter.

## 2. Introduction

### Product Overview

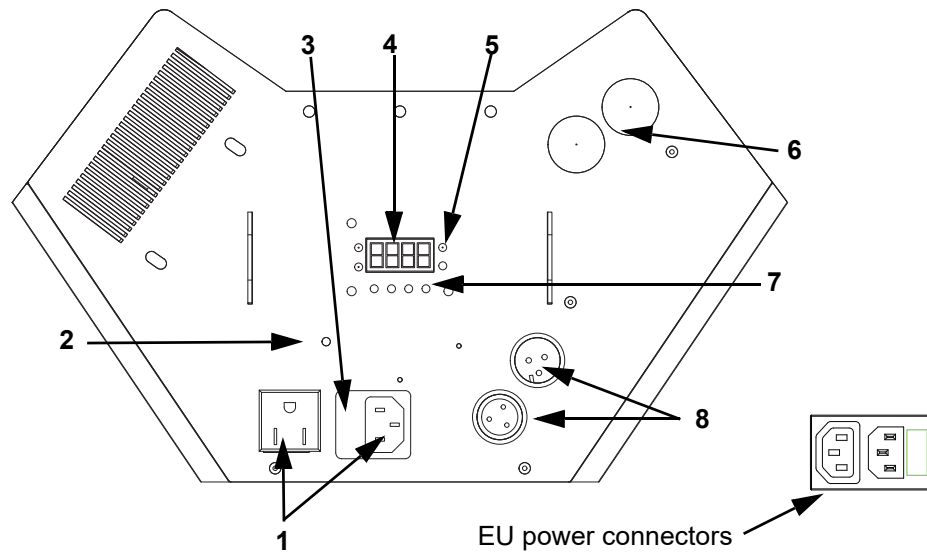

#	Name	#	Name
1	Power in/out	7	Menu buttons
2	IR sensor	8	3-pin DMX in/out
3	Fuse holder	9	Lens
4	Display	10	Barrel
5	LED indicators	11	Easy access door
6	Safety loop		

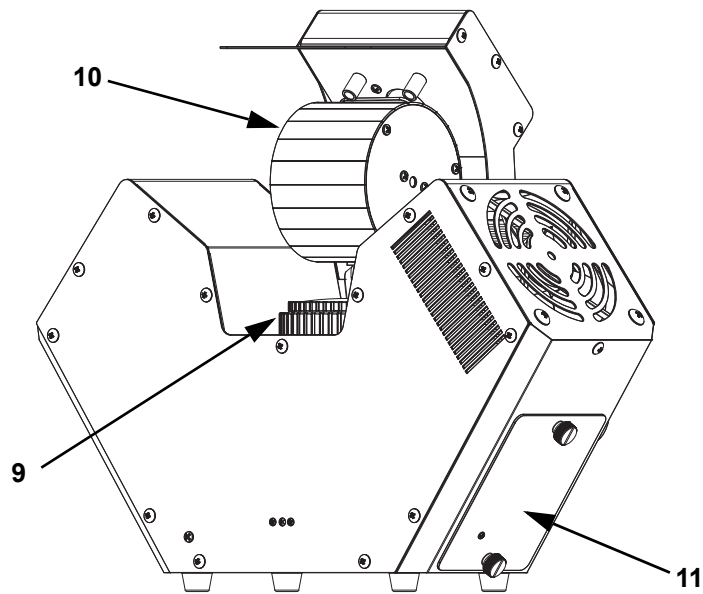

Product Dimensions

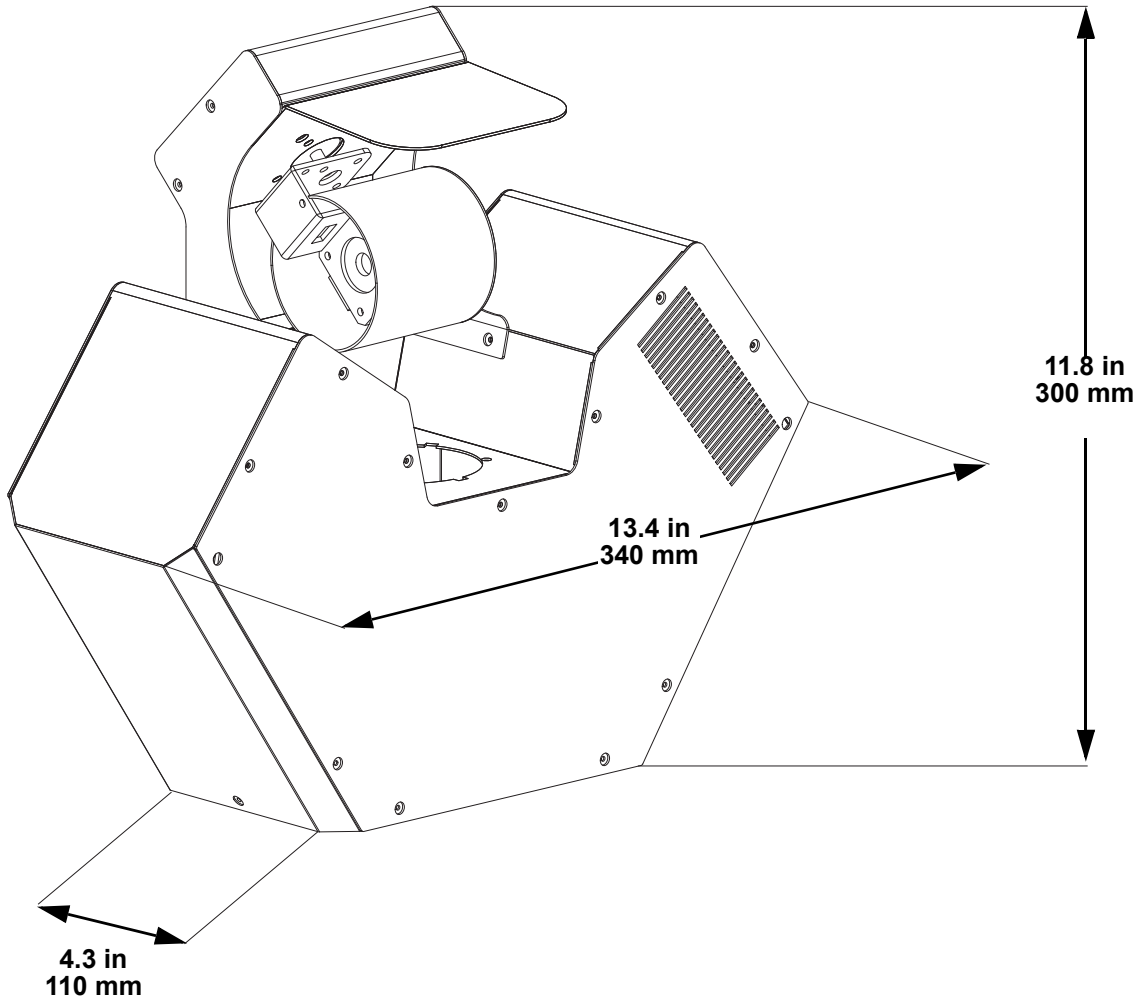

### 3. Setup

#### AC Power

The Blazor has an auto-ranging power supply and it can work with an input voltage range of 100 to 240 VAC, 50/60 Hz.

To determine the product's power requirements (circuit breaker, power outlet, and wiring), use the current value listed on the label affixed to the product's back panel, or refer to the product's specifications chart. The listed current rating indicates the product's average current draw under normal conditions.



- **Always connect the product to a protected circuit (a circuit breaker or fuse). Make sure the product has an appropriate electrical ground to avoid the risk of electrocution or fire.**
- **To eliminate unnecessary wear and improve its lifespan, during periods of non-use completely disconnect the product from power via breaker or by unplugging it.**



**Never connect the product to a rheostat (variable resistor) or dimmer circuit, even if the rheostat or dimmer channel serves only as a 0 to 100% switch.**

#### Fuse Replacement

1. Disconnect the product from power.
2. Wedge the tip of a flat-head screwdriver into the slot of the fuse holder.
3. Pry the fuse holder out of the housing.
4. Remove the blown fuse from the holder and replace with a fuse of the exact same type and rating.
5. Insert the fuse holder back in place and reconnect power.

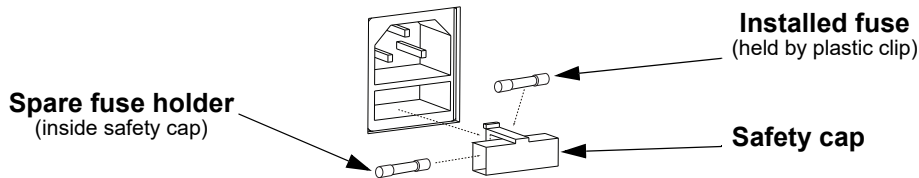

**Disconnect the product from the power outlet before replacing the fuse.**



**Always replace a blown fuse with one of the same type and rating.**

#### Power Linking

This product provides power linking via the outlet located in the back of the product. See the diagram below for further explanation.

#### Power Linking Diagram

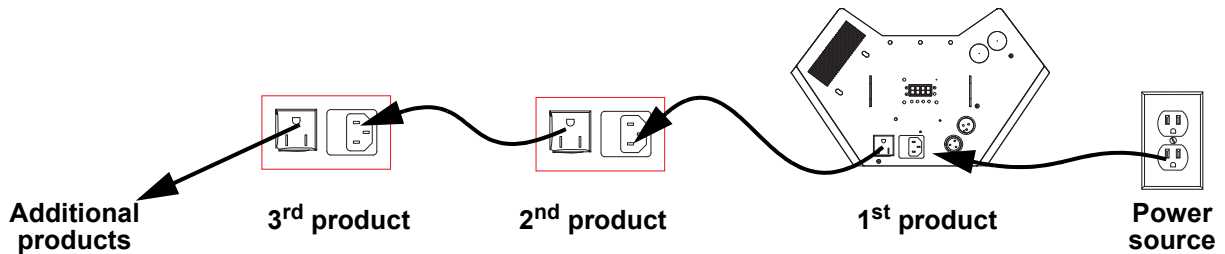

**It is possible to link up to 3 Blazor products on 120 VAC or up to 5 products on 230 VAC.**



**The power linking diagram shown above corresponds to the North American version of the product ONLY! If using the product in other markets, consult with the local Chauvet distributor as power linking connectors and requirements may differ by country or region.**



## Setup

### Mounting

Before mounting the product, read and follow the safety recommendations indicated in the [Safety Notes](#).

### Orientation

The Blazor may be mounted in any position; however, make sure adequate ventilation is provided around the product.

### Rigging

- Before deciding on a location for the product, always make sure there is easy access to the product for maintenance and programming.
- Make sure that the structure and attachment points can support the weight before hanging the product (see the [Technical Specifications](#) section for weight information).
- When mounting the product overhead, always use a safety cable. Mount the product securely to a rigging point, such as an elevated platform or a truss.
- When rigging the product onto a truss, use a mounting clamp of appropriate weight capacity. The bracket has a 13-mm hole, which is appropriate for this purpose.
- The bracket adjustment knobs allow for directional adjustment when aiming the product to the desired angle. Only loosen or tighten the bracket knobs manually. Using tools could damage the knobs.
- When power linking multiple products, mount the products close enough for power linking cables to reach.
- When mounting the product on the floor, make sure that the product and cables are away from people and vehicles.

### Mounting Diagram

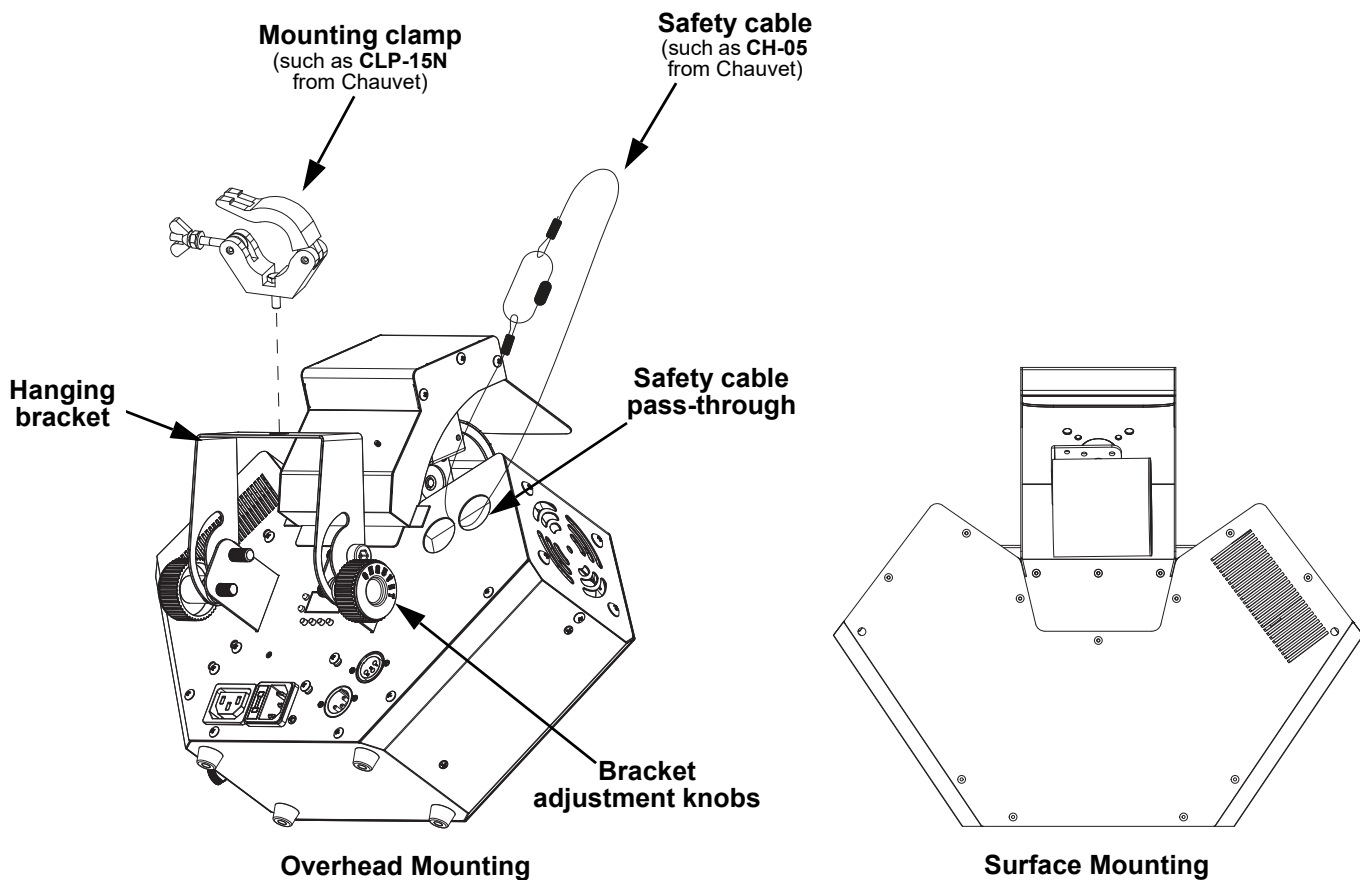

## Gobo Wheels

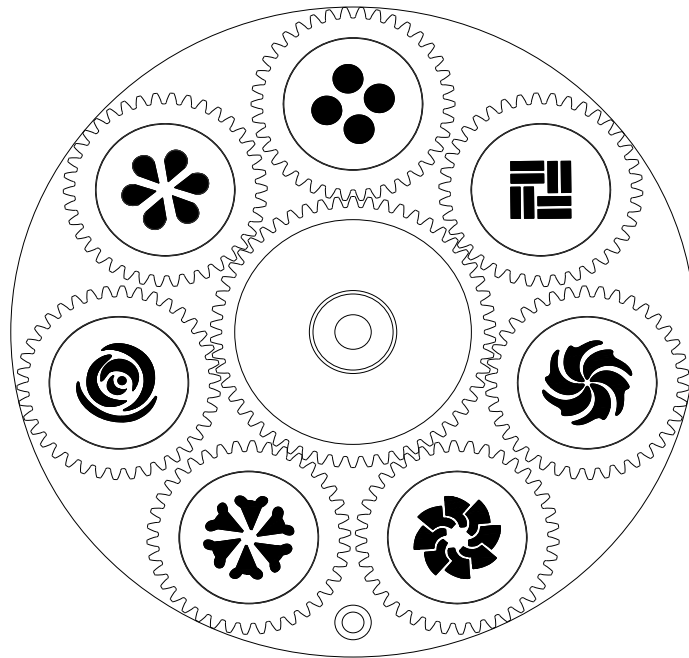

### Replacing Gobos

Gobos in the Blazor can be changed using the easy-access gobo door on side of the fixture. To remove and replace gobos in the Blazor:

1. Loosen the two screws holding the easy-access gobo door. Remove the door to gain access to the gobo wheel.
2. Gently pry the individual gobo holder by pushing and sliding it away from the gobo wheel. Do this with each gobo that requires removal.
3. To replace a gobo, carefully slide the individual gobo holder into a slot in the gobo wheel. Make sure that the two prongs in the gobo holder align with the two holes in the gobo wheel. Gently press the gobo holder into the gobo wheel until it clicks in place.
4. Replace the easy-access door and tighten the two screws to hold it in place.

### Rotating Gobo Dimensions

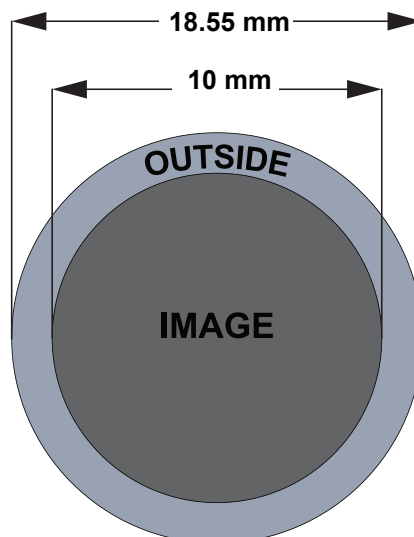

## 4. Operation

### Control Panel Operation

To access the control panel functions, use the four buttons located underneath the display. Please refer to the [Product Overview](#) to see the button locations on the control panel.

Button	Function
<MENU>	Press to find an operation mode or to back out of the current menu option
<UP>	Press to scroll up the list of options or to find a higher value
<DOWN>	Press to scroll down the list of options or to find a lower value
<ENTER>	Press to activate a menu option or a selected value

### Menu Map

Refer to the Blazor product page on [www.chauvetdj.com](http://www.chauvetdj.com) for the latest menu map and software.

Mode	Programming Levels		Description
Address	4Ch	A001–509	DMX address
	11Ch	A001–502	DMX address
Auto Program	P--	Auto	Current auto show
Auto Speed	S--	S001–100	Auto speed
Sound Mode	Snd1	bo	Blackout when no sound
		SLoU	Rotate slow when no sound
	Snd2	bo	Blackout when no sound
		SLoU	Rotate slow when no sound
	Snd3	bo	Blackout when no sound
		SLoU	Rotate slow when no sound
Sound Sensitivity	SEnu	u001–100	Sound sensitivity
Dimmer	dIn	d001–100	Master dimmer for auto, manual, and sound-active
Manual mode	CoLo	C000–255	Selects color
	Gobo	G001–007	Selects gobo
	Goro	1 001–042	Gobo rotation index
		1 043–085	Stop
		1 086–129	Rotation counterclockwise, slow to fast
		1 130–222	Stop
		1 223–255	Alternating clockwise-counterclockwise, slow to fast
	n-SP	r001–086	Mirror dish rotation clockwise, slow to fast
		r087–129	Stop
		r130–222	Mirror dish rotation counter-clockwise, slow to fast
		r223–255	Mirror dish rotation bounce, slow to fast
	b-SP	t001–086	Barrel rotation up speed, slow to fast
		t087–129	Stop
		t130–222	Barrel rotation down speed, slow to fast
		t223–255	Barrel rotation bounce speed, slow to fast
	b-PA	P000–128	Barrel pan index
		P129–255	Barrel pan bounce, slow to fast
	Infrared Mode	SEt	on
oFF			Turns infrared off
Slave mode	SLU	SLu1	Copies the master unit
		SLu2	Slave unit for coordinated show

Mode	Programming Levels		Description
Motor	not	000-100	Override mirror dish or gobo rotation for auto/sound only. If set to 000, this setting has no effect. When set to 050, the mirror dish will rotate at 50% speed and the auto or sound program speed control will control the colors and gobos only.
	rGob		

### DMX Configuration

The Blazor works with a DMX controller. Information about DMX is in the Chauvet DMX Primer, which is available from the Chauvet website [chauvetlighting.com/downloads/DMX\\_Primer\\_rev05\\_WO.pdf](http://chauvetlighting.com/downloads/DMX_Primer_rev05_WO.pdf).

### Personality and Starting Address

The Blazor uses up to 11 DMX channels in the **11** DMX mode, which defines the highest configurable address to **502**.

When selecting a starting DMX address, always consider the number of DMX channels the DMX mode uses. If the starting address is set too high, access to some channels could be restricted.

For information about the DMX protocol, download the DMX Primer from [www.chauvetdj.com](http://www.chauvetdj.com).

To select the personality and starting address, do the following:

1. Press **<MENU>** repeatedly until **4Ch**, or **11Ch** shows on the display.
2. Press **<ENTER>**.
3. Use **<UP>** or **<DOWN>** to select the starting address, from **A001–509**.
4. Press **<ENTER>**.

## DMX Channel Assignments and Values

### DMX Charts

4Ch	11Ch	Function	Value	Percent/Setting
1	1	Auto program	001 ⇔ 127	Auto mode
			128 ⇔ 255	Sound mode
2	2	Auto speed	000 ⇔ 255	Slow to fast (activates when Ch 1 is in auto mode)
		Sound sensitivity		Activates at 0-100% when Ch 1 is in sound mode
3	3	Dimmer	000 ⇔ 255	0–100%
–	4	Strobe	000 ⇔ 015	Open
			016 ⇔ 255	Strobe, slow to fast
–	5	Color	000 ⇔ 009	White
			010 ⇔ 019	Red
			020 ⇔ 029	Green
			030 ⇔ 039	Blue
			040 ⇔ 049	Yellow
			050 ⇔ 059	Amber
			060 ⇔ 069	Magenta
			070 ⇔ 079	Magenta + white
			080 ⇔ 089	Magenta + amber
			090 ⇔ 099	Amber + yellow
			100 ⇔ 109	Yellow + blue
			110 ⇔ 119	Blue + green
			120 ⇔ 129	Green + red
			130 ⇔ 139	Red + white
			140 ⇔ 197	Color scroll, clockwise, fast to slow
198 ⇔ 255	Color scroll, counterclockwise, fast to slow			
–	6	Gobo	000 ⇔ 019	Gobo 1
			020 ⇔ 039	Gobo 2
			040 ⇔ 059	Gobo 3
			060 ⇔ 079	Gobo 4
			080 ⇔ 099	Gobo 5
			100 ⇔ 119	Gobo 6
			120 ⇔ 139	Gobo 7
			140 ⇔ 197	Gobo scroll, clockwise, fast to slow
			198 ⇔ 255	Gobo scroll, counterclockwise, fast to slow
–	7	Gobo rotation	001 ⇔ 042	Gobo index
			043 ⇔ 086	Stop
			087 ⇔ 129	Rotation, slow to fast
			130 ⇔ 222	Stop
			223 ⇔ 255	Alternating clockwise-counterclockwise, slow to fast
–	8	Mirror rotation	001 ⇔ 086	Mirror rotation, clockwise, slow to fast
			087 ⇔ 129	Stop
			130 ⇔ 222	Mirror rotation, counter-clockwise, slow to fast
			223 ⇔ 255	Mirror bounce, slow to fast

4Ch	11Ch	Function	Value	Percent/Setting
-	9	Barrel rotation	001 ⇔ 086	Barrel scroll, slow to fast
			087 ⇔ 129	Stop
			130 ⇔ 222	Reverse barrel scroll, slow to fast
			223 ⇔ 255	Barrel bounce, slow to fast
-	10	Barrel pan	000 ⇔ 128	0-100%
			129 ⇔ 255	Pan bounce, slow to fast
4	11	Control	000 ⇔ 095	No function
			096 ⇔ 103	Pan reset
			104 ⇔ 111	Tilt reset
			112 ⇔ 119	Color wheel reset
			120 ⇔ 127	Gobo wheel reset
			128 ⇔ 151	All reset
			152 ⇔ 255	No function

### Standalone Configuration

Set the product in one of the standalone modes to operate without a DMX controller.



**Never connect a product that is operating in any standalone mode to a DMX string connected to a DMX controller. Products in standalone mode may transmit DMX signals that could interfere with the DMX signals from the controller.**

### Auto Programs

To run the Blazor with an Auto program, follow the instructions below.

1. Press **<MENU>** repeatedly until **P--** shows on the display.
2. Press **<ENTER>**.

### Auto Speed

To set the speed of the auto program, do the following:

1. Press **<MENU>** repeatedly until **S--** shows on the display.
2. Press **<ENTER>**.
3. Use **<UP>** or **<DOWN>** to increase or decrease the auto program speed, from **S001–100**.
4. Press **<ENTER>**.

### Sound-Active Mode

To run the Blazor with a sound-active program, follow the instructions below.

1. Press **<MENU>** repeatedly until **Snd1**, **Snd2**, or **Snd3** shows on the display.
2. Press **<ENTER>**.
3. Use **<UP>** or **<DOWN>** to select how the product will respond when no sound is detected, from **bo** (blackout), or **SLoU** (slows down).
4. Press **<ENTER>**.

### Sound Sensitivity

To set the sound sensitivity of the product, do the following:

1. Press **<MENU>** repeatedly until **SEnu** shows on the display.
2. Press **<ENTER>**.
3. Use **<UP>** or **<DOWN>** to increase or decrease the sound sensitivity, from **u001–100**.
4. Press **<ENTER>**.



**The product will only respond to low frequencies of music (bass and drums).**

### Dimmer

To set the intensity of the Blazor, do the following:

1. Press **<MENU>** repeatedly until **dIn** shows on the display.
2. Press **<ENTER>**.
3. Use **<UP>** or **<DOWN>** to increase or decrease the auto program speed, from **d001–100**.
4. Press **<ENTER>**.

### Manual Mode

#### Color

To select a color from the color wheel, do the following:

1. Press **<MENU>** repeatedly until **CoLo** shows on the display.
2. Press **<ENTER>**.
3. Use **<UP>** or **<DOWN>** to increase or decrease the auto program speed, from **C000–255**.
4. Press **<ENTER>**.

#### Gobo

To select a Gobo from the gobo wheel, do the following:

1. Press **<MENU>** repeatedly until **Gobo** shows on the display.
2. Press **<ENTER>**.
3. Use **<UP>** or **<DOWN>** to increase or decrease the auto program speed, from **G001–007**.
4. Press **<ENTER>**.

### Gobo Rotation

To set the gobo rotation direction, do the following:

1. Press **<MENU>** repeatedly until **Goro** shows on the display.
2. Press **<ENTER>**.
3. Use **<UP>** or **<DOWN>** to select from **1 001–042** (Gobo index), **1 043–085** (Stop gobo index) **1 086–129** (Counter-clockwise, fast to slow), **1 130–222** (Stop counterclockwise rotation), **1 223–255** (Alternating clockwise-counterclockwise rotation).
4. Press **<ENTER>**.

### Mirror Speed

To select Speed of the mirror dish, do the following:

1. Press **<MENU>** repeatedly until **n-SP** shows on the display.
2. Press **<ENTER>**.
3. Use **<UP>** or **<DOWN>** to increase or decrease the mirror speed, from **r001–086** (Mirror dish rotation, clockwise), **r087–129** (Stop mirror rotation), **r130–222** (Mirror dish rotation, counterclockwise), **r223–255** (Mirror dish rotation bounce).
4. Press **<ENTER>**.

### Barrel Rotation

To select Speed of the barrel, do the following:

1. Press **<MENU>** repeatedly until **b-SP** shows on the display.
2. Press **<ENTER>**.
3. Use **<UP>** or **<DOWN>** to increase or decrease the barrel scroll speed, from **t001–086** (Barrel scroll), **t087–129** (Stop barrel scroll), **t130–222** (Barrel reverse scroll), **t223–255** (Barrel bounce scroll).
4. Press **<ENTER>**.

### Barrel Pan

To select Pan of the barrel, do the following:

1. Press **<MENU>** repeatedly until **b-PA** shows on the display.
2. Press **<ENTER>**.
3. Use **<UP>** or **<DOWN>** to increase or decrease the barrel pan speed, from **P000–128** (Barrel pan index), **P129–255** (Barrel pan bounce).
4. Press **<ENTER>**.

## Motor Control Mode

### Mirror rotation:

To set the mirror rotation speed, do the following:

1. Press **<MENU>** repeatedly until **Not** shows on the display.
2. Press **<ENTER>**.
3. Press **<ENTER>** to select from **N000** (no function) to **N100** (highest speed).
4. Press **<ENTER>**.

### Gobo rotation:

To set the gobo rotation speed, do the following:

1. Press **<MENU>** repeatedly until **rGob** shows on the display.
2. Press **<ENTER>**.
3. Press **<ENTER>** to select from **N000** (no function) to **N100** (highest speed).
4. Press **<ENTER>**.



## Operation

### IRC-6 Infrared Remote Control

The Blazor is compatible with the IRC-6 infrared remote control from Chauvet.

To enable or disable IRC-6 functionality, do the following:

1. Press **<MENU>** repeatedly until **SEt** shows on the display.
2. Press **<ENTER>**.
3. Press **<ENTER>** to select from **on** (enable), or **oFF** (disable).
4. Press **<ENTER>**.

Consult the table below to operate the Blazor with the IRC-6.

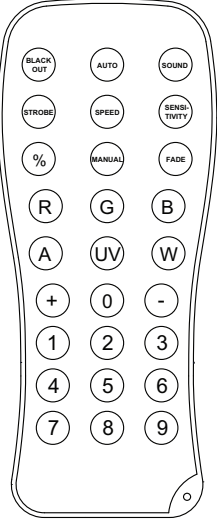
IRC-6	Button	Function
	<b>&lt;AUTO&gt;</b>	Press to activate automatic mode, then use <b>&lt;+&gt;</b> or <b>&lt;-&gt;</b> to select a program
	<b>&lt;SPEED&gt;</b>	Press then use <b>&lt;+&gt;</b> or <b>&lt;-&gt;</b> to increase or decrease speed
	<b>&lt;SOUND&gt;</b>	Press to activate sound-active mode, then use <b>&lt;+&gt;</b> or <b>&lt;-&gt;</b> to select a program
	<b>&lt;SENSITIVITY&gt;</b>	Press then use <b>&lt;+&gt;</b> or <b>&lt;-&gt;</b> to increase or decrease sensitivity
	<b>&lt;STROBE&gt;</b>	Press to toggle strobe, then use <b>&lt;+&gt;</b> or <b>&lt;-&gt;</b> to increase or decrease strobe speed
	<b>&lt;%&gt;</b>	Press then use <b>&lt;+&gt;</b> or <b>&lt;-&gt;</b> to increase or decrease the dimmer
	<b>&lt;FADE&gt;</b>	Press to activate fade mode
	<b>&lt;MANUAL&gt;</b>	Press to enable manual color control
	<b>&lt;1&gt;</b>	Press to select the color white
	<b>&lt;2&gt;</b>	Press to select the color red
	<b>&lt;3&gt;</b>	Press to select the color green
	<b>&lt;4&gt;</b>	Press to select the color blue
	<b>&lt;5&gt;</b>	Press to select the color yellow
	<b>&lt;6&gt;</b>	Press to select the color orange
	<b>&lt;7&gt;</b>	Press to select the color ultraviolet
	<b>&lt;BLACK OUT&gt;</b>	Press to turn off all the lights until the button is pressed again. NOTE: The IRC-6 will not respond to any inputs when Black Out is activated. If the product does not respond when a button is pressed, try pressing <b>&lt;BLACK OUT&gt;</b> . Black Out may have been activated.



- Any setting on the IRC-6 will be saved until the system is rebooted. The system will revert to Auto Mode after reboot.
- The buttons on the IRC-6 not listed above are reserved for future use.

## Master/Slave Mode

The Master/Slave mode allows a single Blazor product (the “master”) to control the actions of one or more Blazor products (the “slaves”) without the need of a DMX controller. The master product will be set to operate in either standalone mode or with the IRC-6, while the slave products will be set to operate in slave mode. Once set and connected, the slave products will operate in unison with the master product.

Configure the products as indicated below.

### Slave products:

1. Press **<MENU>** repeatedly until **SLU** shows on the display.
2. Press **<ENTER>**.
3. Use **<UP>** or **<DOWN>** to set the starting address to **SLu1** or **SLu2**.
4. Press **<ENTER>**.
5. Connect the DMX input of the first slave product to the DMX output of the master product.
6. Connect the DMX input of the subsequent slave products to the DMX output of the previous slave product.
7. Finish setting and connecting all the slave products.

### Master product:

1. Set the master product to operate in standalone mode or with the IRC-6.
2. Make the master product the first product in the DMX daisy chain.



- **Configure all the slave products before connecting the master to the daisy chain.**
- **Never connect a DMX controller to a DMX string configured for Master/Slave operation because the controller may interfere with the signals from the master.**
- **Do not connect more than 31 slaves to the master.**

## 5. Maintenance

### Product Maintenance

Dust build-up reduces light output performance and can cause overheating. This can lead to reduction of the light source's life and/or mechanical wear. To maintain optimum performance and minimize wear, clean all lighting products at least twice a month. However, be aware that usage and environmental conditions could be contributing factors to increase the cleaning frequency.

To clean the product, follow the instructions below:

1. Unplug the product from power.
2. Wait until the product is at room temperature.
3. Use a vacuum (or dry compressed air) and a soft brush to remove dust collected on the external surface/vents.
4. Clean all transparent surfaces with a mild soap solution, ammonia-free glass cleaner, or isopropyl alcohol.
5. Apply the solution directly to a soft, lint free cotton cloth or a lens cleaning tissue.
6. Softly drag any dirt or grime to the outside of the transparent surface.
7. Gently polish the transparent surfaces until they are free of haze and lint.



**Always dry the transparent surfaces carefully after cleaning them.**



**Do not spin the cooling fans using compressed air because they could be damaged.**

### Gobo Maintenance

To ensure optimal operation, 1) inspect and 2) clean gobos every four months. More frequent maintenance may be necessary if usage is higher.

To inspect, remove each gobo holder and check if:

- the holders are clean (free of dirt, grime, or gunk).
- the gobos are properly installed in the holders.
- all the bearings are in place.
- the holders are rotating freely.

To clean the gobos and the gobo holder, follow the instructions below:

1. Remove the gobos from the holder.
2. Clean the gobos with a soft, lint-free cotton cloth. Use an ammonia-free glass cleaner sprayed to a piece of lint-free cotton cloth to clean glass gobos.
3. Submerge the gobo holder (without the gobo installed) in a container with a liquid lubricant (i.e., WD40) and let it rest for a couple of minutes.
4. Shake the container with the gobo holder inside to help release/loosen any gunk/grime/dirt.
5. Take the gobo holder out of the container and clean it using a small nylon brush.
6. Wipe off all the lubricant from the gobo holder using a piece of lint-free cotton cloth.
7. Apply a small coat of synthetic oil (i.e., Liquid Bearings) to the bearings and rotate it thoroughly in both directions (needle tip applicator recommended). Make sure the gobo holder is rotating freely and is not making any abnormal noise.
8. Reinstall the gobos in the gobo holder. Make sure the gobos are in the correct positions.
9. Reinstall the gobo holder in the unit.

## 6. Technical Specifications

### Dimensions and Weight

Length	Width	Height	Weight
13.4 in (340 mm)	9.05 in (230 mm)	12.2 in (310 mm)	9 lb (4.08 kg)

**Note:** Dimensions in inches are rounded.

### Power

Power Supply Type	Range	Voltage Selection
Switching (internal)	100 to 240 VAC, 50/60 Hz	Auto-ranging

Parameter	120 V, 60 Hz	230 V, 50 Hz
Consumption	166 W	160 W
Operating Current	2.4 A	1.5 A
Power linking current (products)	8A (3 products)	8A (5 products)
Fuse	F 3 A, 250V	F 3 A, 250 V

Power I/O	U.S./Worldwide	UK/Europe
Power input connector	IEC	IEC
Power output connector	Edison	IEC
Power cable plug	Edison (U.S.)	Local Plug

### Light Source

Type	Quantity	Power	Current	Lifespan
LED	1	115 W	4 A	50,000 hours

### Thermal

Maximum External Temperature	Cooling System
104 °F (40 °C)	Fan-assisted convection

### DMX

I/O Connector	Channel Range
3-pin XLR	4 or 11

### Ordering

Product Name	Item Code	UPC Number
Blazor	07052549	781462228972



## Contact Us

General Information	Technical Support
<b>Chauvet World Headquarters</b>	
Address: 3360 Davie Rd., Suite 509 Davie, FL 33314 Voice: (954) 577-4455 Fax: (954) 929-5560 Toll Free: (800) 762-1084	Voice: (844) 393-7575 Fax: (954) 756-8015 Email: <a href="mailto:chauvetcs@chauvetlighting.com">chauvetcs@chauvetlighting.com</a> Website: <a href="http://www.chauvetdj.com">www.chauvetdj.com</a>
<b>Chauvet U.K.</b>	
Address: Pod 1 EVO Park Little Oak Drive, Sherwood Park Nottinghamshire, NG15 0EB UK Voice: +44 (0) 1773 511115 Fax: +44 (0) 1773 511110	Email: <a href="mailto:UKtech@chauvetlighting.eu">UKtech@chauvetlighting.eu</a> Website: <a href="http://www.chauvetdj.eu">www.chauvetdj.eu</a>
<b>Chauvet Benelux</b>	
Address: Vaartlaan 9 9800 Deinze Belgium Voice: +32 9 388 93 97	Email: <a href="mailto:BNLtech@chauvetlighting.eu">BNLtech@chauvetlighting.eu</a> Website: <a href="http://www.chauvetdj.eu">www.chauvetdj.eu</a>
<b>Chauvet France</b>	
Address: 3, Rue Ampère 91380 Chilly-Mazarin France Voice: +33 1 78 85 33 59	Email: <a href="mailto:FRtech@chauvetlighting.fr">FRtech@chauvetlighting.fr</a> Website: <a href="http://www.chauvetdj.eu">www.chauvetdj.eu</a>
<b>Chauvet Germany</b>	
Address: Bruno-Bürgel-Str. 11 28759 Bremen Germany Voice: +49 421 62 60 20	Email: <a href="mailto:DEtech@chauvetlighting.de">DEtech@chauvetlighting.de</a> Website: <a href="http://www.chauvetdj.eu">www.chauvetdj.eu</a>
<b>Chauvet Mexico</b>	
Address: Av. de las Partidas 34 - 3B (Entrance by Calle 2) Zona Industrial Lerma Lerma, Edo. de México, CP 52000 Voice: +52 (728) 690-2010	Email: <a href="mailto:servicio@chauvet.com.mx">servicio@chauvet.com.mx</a> Website: <a href="http://www.chauvetdj.mx">www.chauvetdj.mx</a>

## Warranty & Returns

For warranty terms and conditions and return information, please visit our website.

For customers in the United States and Mexico: [www.chauvetlighting.com/warranty-registration](http://www.chauvetlighting.com/warranty-registration).

For customers in the United Kingdom, Republic of Ireland, Belgium, the Netherlands, Luxembourg, France, and Germany: [www.chauvetlighting.eu/warranty-registration](http://www.chauvetlighting.eu/warranty-registration).